

Installing the Enphase AC Battery

To install the Enphase AC Battery™ (“AC Battery”) and the Enphase Wall Mount Bracket, read and follow all warnings and instructions in this Guide and in the *Enphase AC Battery Installation and Operation Manual* at enphase.com/support. Safety warnings are listed on the back of this guide. These instructions are not meant to be a complete explanation of how to design and install an energy storage system. All installations must comply with national and local electrical codes and standards. **Only qualified electricians shall install, troubleshoot, or replace the AC Battery.**

The Enphase Storage System includes the Enphase AC Battery with integrated Enphase Microinverter™. The system uses the Enphase Envoy-S Metered™ to measure PV production and home energy consumption. The system knows when it is optimal to charge or discharge battery power so that energy is stored when it is abundant and used when scarce.

PREPARATION

- A) Inspect the packaging and the AC Battery for damage. Do not install or use the AC Battery if it has been damaged in any way.
- B) Ensure that you have 1) an Enphase AC Battery and 2) an Enphase Wall Mount Bracket. The packages contain:
- The AC Battery shipping box contains an Enphase AC Battery and an access panel cover.
 - **NOTE:** Check the “Must Energize By” label on the shipping box to verify that the AC Battery will be installed by the date shown.
 - The Wall Mount Bracket shipping box includes only the bracket. These are available in two widths to accommodate 450mm and 600mm stud-spacing.
- C) Make sure you have the following **required** items:
- Enphase Envoy-S Metered communications gateway with production CT(s) and consumption CT(s) installed and configured as described in the *Enphase Envoy-S Metered Quick Install Guide*. The Enphase AC Battery is intended to operate with an Internet connection. Failure to maintain an Internet connection may have an impact on the warranty. See Limited Warranty for full terms and services (enphase.com/warranty).
 - Tools: wireway (with fittings and fitting tools), drill, 4mm pilot bit, screwdriver, socket, spanner, adjustable spanner, torque wrench, level, 4mm Allen key, and wire stripper.
 - Four 6 mm diameter lag bolts/screws, 25 to 50mm long depending on attachment wall, for each Wall Mount Bracket. Check with a structural engineer and local standards for requirements for your site.
 - Washers for use between fastener heads and wall mount bracket.
 - 2.5mm² to 4mm² (11mm strip length) copper conductors (rated at 75° C or 90° C) for push terminals.
 - Gland or strain relief fitting (one for each used wireway opening in the AC junction box).
 - 20A maximum over current protection in accordance with AS/NZS 5033, AS/NZS 4777.1 and AS/NZS 3000.
 - Personal protection equipment (PPE) for handling lithium ion batteries as required by local safety standards.
- D) Make sure you have the following **optional** items, if needed:
- 20A maximum AC isolator
 - Stud finder
- E) Install the PV modules, Enphase Microinverters, and Envoy-S as directed by the installation manuals.
- F) Peel the removable serial number label from each battery and affix it to the respective location on the installation map. You will scan this map later using Installer Toolkit and your mobile device. You can find an installation map at the back of any Enphase Microinverter manual.

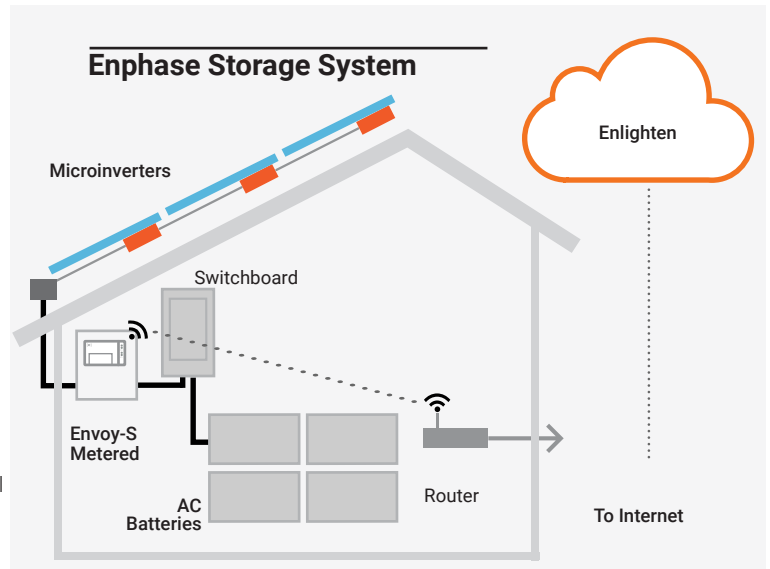

INSTALLATION

Steps one through four describe installation of the wall-mount bracket and junction box wiring, while steps five and six describe mounting the battery and energising the system.

1 Choose a location for the AC Battery array

- The AC Battery housing is an IP-20 rated metallic enclosure. The terminal blocks on the wall mount bracket accept a maximum wire size of 4mm².
- Following local standards:** Choose a readily accessible, well-ventilated, unoccupied indoor location (like a garage), which is out of direct sunlight and where the ambient temperature and humidity are within -20° C to 45° C and 5% to 95% RH, non-condensing.
 - Ensure that the mounting location can sustain the weight of the AC Battery and mounting bracket (28 kg or 60 lbs per battery).
 - Plan the mounting location to be at least 300mm (one foot) off the ground and 300mm (one foot) from the ceiling. Keep the battery(ies) away from falling or moving objects, including motor vehicles.
 - Ensure that there are no pipes or electrical wires where you plan to drill.
 - Plan to maintain at least 300mm (one foot) of clearance in front of each battery.
 - Consider the dimensions of the AC Battery, easy access, height, and length of cable when selecting the location.
 - Do not block the vents or allow liquids to contact the AC Battery. The AC Battery is not waterproof.
 - Select a location where you can connect to the site's switchboard (load centre) using an appropriate branch circuit.
 - Following local standards:** Decide whether to connect using external wireway or by wiring inside the walls. This determines which knockouts to use in the junction box. Check if an AC isolator is needed. Plan the location for the AC isolation switch, if needed.
 - If you are installing more than one AC Battery, continue to maintain minimum required clearances as shown in **Step 2**.



140-00085-01

2 Install the wall mount bracket

- A) Make sure that the wall mount bracket matches the wall stud spacing and that the lowest wall mount bracket position meets clearance requirements as shown.

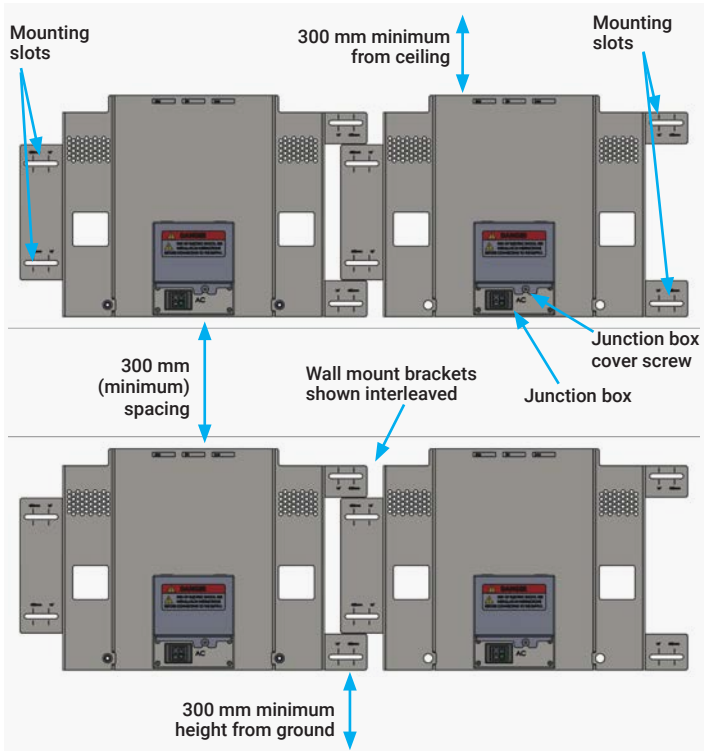

⚠ WARNING! Risk of injury and equipment damage. Protect the AC Battery from impact damage and improper use.

- B) Remove the appropriate knockout(s) for the planned entry into the wall mount bracket junction box:
- If wiring inside the walls, use the knockout(s) in the back of each junction box. If using wireway, use the knockouts at the bottom of the junction box.
 - If installing only one battery, use only one knockout.
 - Loosen the screw securing the junction box cover and remove the cover. Keep the cover handy as you will need it later.

- C) Starting at battery position closest to the power source, mark a level line on the wall as a guide.

⚠ WARNING! Multiple risks. Make sure not to drill or attach into electric wiring or pipes that are in the wall!

- D) Place the wall mount bracket on the wall so that the mark on the bracket aligns with the centre of the stud. Use a level to keep the top of the wall mount bracket flat, and attach the top right corner of the wall mount bracket using one screw and washer for each slot.
- F) Verify that the wall mount bracket is solidly attached to the wall.

⚠ WARNING! Risk of injury and equipment damage. Do not mount an AC Battery on a bracket that is not properly mounted.

- G) If installing additional batteries, install the adjacent wall mount brackets in an interleaved fashion, as needed. Be sure to align the mark on the adjacent wall mount bracket to the centre of the wall stud. A small gap in between the adjacent wall mount brackets is normal. You may install another row of wall mount brackets above the one already installed. Maintain at least 300 mm (one foot) clearance between rows.

3 Install the AC isolator, if required

Following all local codes and standards:

- A) Choose an AC Isolator that can break the maximum rated current of the branch circuit under load (20 A maximum).
- B) Connect one side of the isolator to the switchboard (load centre).
- C) Verify that AC voltage at the site is within range: single-phase L1 to N measures 200-270 VAC.

⚠ WARNING! Risk of equipment failure. Size the AC wire gauge to account for voltage rise for both the branch circuit and all upstream conductors leading back to the PCC (point of common coupling). Refer to the technical brief on voltage rise at enphase.com/support.

4 Wire the junction box

- A) Size the electric wiring (Line, Neutral and Ground) depending on the upstream breaker or fuse. Use 2.5 mm² - 4mm² wire with maximum 20A branch circuit protection.

⚠ DANGER! Risk of electric shock. Check that the dedicated circuit breaker protecting the branch where the AC Battery will be connected is turned off before wiring.

⚠ WARNING! Risk of equipment damage. Never connect an Enphase AC Battery junction box to two active conductors. Always connect to one Line (active) and one Neutral.

- B) Using the wires and suitable wireways, connect the AC isolator (if used) and the first adjacent AC Battery junction box. Use the openings provided by the knockouts to connect the wireways and pass the wires through them.

NOTE: Do not modify or rewire the pre-installed wiring or bonding connections in the junction box.

- C) Connect each wire in the junction box to its corresponding conductor (Line, Neutral and Ground). Each push terminal accepts two 2.5mm² - 4mm² conductors (11mm strip length). Use a screw driver to depress the terminal.

NOTE: Maintain wire colours as listed.

Junction box colour code	Colour code (AU)
Brown - L1 (Active)	Red - L1 (Active)
Blue - Neutral	Black - Neutral
Green/Yellow - Ground/PE	Green - Ground/PE

- D) After all wires in the junction box are connected and secured, check that there are no exposed conductors.
- E) If connecting additional AC Batteries, be sure to use another wireway and another set of wires to connect out of the junction box to the next junction box.
- F) Gently arrange all the wires and connectors inside the junction box and replace the cover. Tighten the cover screw using a Phillips screw driver.

⚠ DANGER! Risk of electric shock. The system is not ready to be energised! Do not close the circuit breaker yet.

Junction box detail

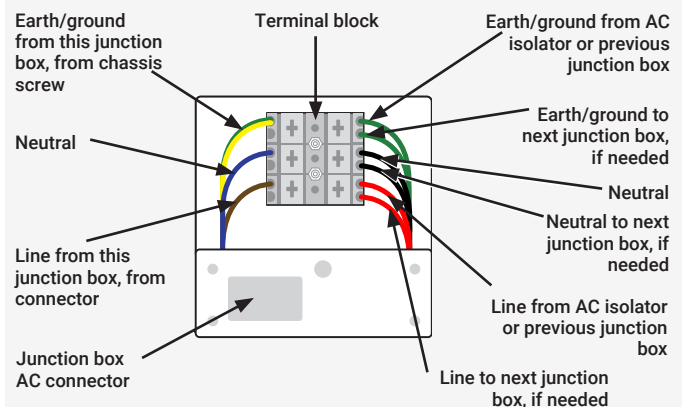

5 Mount the AC Battery on the wall

⚠ WARNING! Risk of injury and equipment damage. Avoid dropping the AC Battery. Doing so may create a hazard, cause serious injury, and/or damage the equipment.

⚠ WARNING: Before mounting the Enphase AC Battery, ensure that the junction box cover is secured!

⚠ WARNING: Take care when lifting the AC Battery. The AC Battery is heavy and may require two persons to lift.

- A) Using both hands, take the AC Battery from the packaging and place it right side up on a flat surface. Be sure that the AC connector is not pinched underneath.

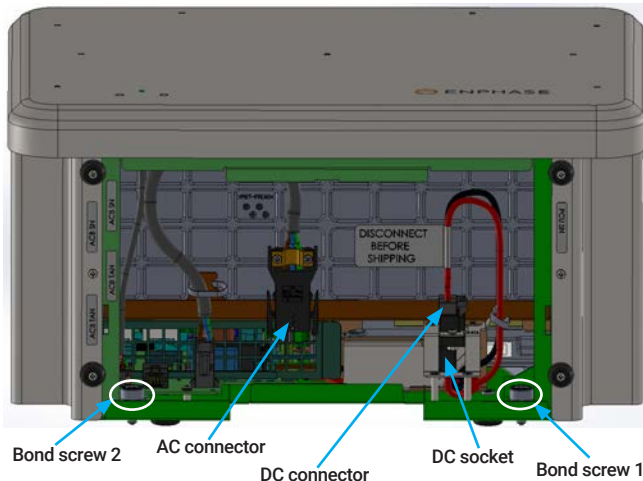

- B) Begin by installing the AC Battery located closest to the main supply. Using the two grip inserts on the side of the AC Battery, lift and carry the AC Battery to the installed wall mount bracket.
- C) While setting the AC Battery onto the wall mount bracket, ensure that the four tabs on the AC Battery are inserted into their corresponding openings in the wall mount bracket. After the tabs are inserted, begin lowering the AC Battery slowly to ensure that the tabs have latched onto the wall mount bracket.

⚠ WARNING! Risk of injury and equipment damage. Do not release the AC Battery until you ensure that all four tabs have safely latched onto the wall mount bracket.

⚠ WARNING! Risk of equipment damage. When placing the AC Battery on the wall mount bracket, ensure that the junction box does not pinch the DC Connector, the AC Connector, or its cable.

- D) Use a Phillips #2 screwdriver to secure the two bond screws into the wall mount bracket. The bond screws are accessible through the bottom access compartment. The bond screws provide an earthing (grounding) bond between the AC Battery and the wall mount bracket.

⚠ WARNING! Always secure the bond screws to ensure earthing (grounding) bond and firm mechanical attachment of AC Battery to wall mount bracket.

- E) Plug the DC Connector into the DC Socket. Listen for a clicking sound as the connectors engage.

NOTE: This action connects the internal battery to the internal electronics; you **must** disconnect it if you move the AC Battery.

NOTE: Check that the wall mount bracket junction box is fully inside the access compartment of the AC Battery. The AC Battery **must not** rest on the junction box or rely on it for support.

- F) Connect the battery AC Connector into the AC connector on the junction box. Listen for a clicking sound as the connectors engage.

- G) Attach the bottom access plate and secure the two compression half-turn latches using a 4mm Allen key.

6 Energise the system

- A) Check that the AC Battery bottom access plate is closed and secured.
- B) Turn on the circuit feeding the AC Battery(ies).
- C) The Enphase AC Battery LED should now be solid red for the duration of the startup process. If the LED is not solid red, see following section on Troubleshooting.

CONFIGURE and ACTIVATE

Follow the instructions in the *Envoy-S Metered Quick Install Guide* to Detect Devices, Configure the System, and Activate Monitoring.

After the Envoy-S has detected the AC Battery(ies), the AC Battery LEDs operate as described in the following section.

TROUBLESHOOTING

a LED overview

The LED lights red while the AC Battery boots up. If the LED remains red for more than two minutes, the battery is in trickle charge mode and will remain so until it reaches a minimum state of charge (up to 30 minutes). After the AC Battery is booted up, the LED becomes blue or green (depending on the charge level). If the LED remains red after one hour or changes to a flashing red state, contact Enphase Customer Support at enphase.com/global/support/contact.

State	Description
Solid red	Start up (default)
Red flashes in sequences of 2	Error. See the following section.
Alternating red and green	High temperature
Solid green	Fully charged or nearly full (75% +)
Green 70%, blue 30%	50-74% charged
Green 30%, blue 70%	25-49% charged
Blue solid	0-24% charged
Slow blue pulse	Discharging
Slow green pulse	Charging
Green one second flashing	Looking for noncommissioned unit

b Resolutions

If the AC Battery is not operating correctly, perform the following steps. If the issue persists, contact Enphase Customer Support at enphase.com/global/support/contact.

- A) If the AC Battery does not operate, check the temperature in the room and increase cooling and/or ventilation as required. Check that the front and sides of the AC Battery have at least 30mm of unobstructed clearance.
- B) If the AC Battery LED is off, turn off the breaker for the branch circuit, wait for at least one minute, and turn it back on.
- C) During a brownout or blackout, the AC Battery powers down automatically. This is normal. When power is restored, it automatically starts up again.
- D) If you do not see AC Battery information in Enlighten, check that the Envoy-S and the Internet connection are working.
- E) Refer to the *AC Battery Installation and Operation Manual* at enphase.com/support to read more about troubleshooting AC Battery operation.

SAFETY

IMPORTANT SAFETY INSTRUCTIONS. SAVE THESE INSTRUCTIONS. This guide contains important instructions that you must follow during installation and maintenance of the Enphase AC Battery. Failing to follow any of these instructions voids the warranty (enphase.com/warranty).

In Case of Fire or Other Emergency

In all cases:

- If safe to do so, switch off the AC breaker for the AC Battery circuit, and if an isolator switch is present, switch off the AC isolator for the AC Battery circuit.
- Contact the fire department or other required emergency response team.
- Evacuate the area.

In case of fire:

- When safe, use a fire extinguisher. Suitable types are A, B, and C dry chemical fire extinguishers. Additional extinguishing media include carbon dioxide, or alcohol-resistant foams.



In case of flooding:

- Stay out of water if any part of the AC Battery or wiring is submerged.
- If possible, protect the system by finding and stopping the source of the water, and pumping it away.
- Let the area dry completely before use.













In case of unusual noise, smell or smoke:

- Ensure nothing is in contact with the AC Battery or in the venting area on top of the AC Battery.
- Ventilate the room.
- Contact Enphase Customer Support at enphase.com/global/support/contact.





















Safety and Advisory Symbols

	DANGER: This indicates a hazardous situation, which if not avoided, will result in death or serious injury.
	WARNING: This indicates a situation where failure to follow instructions may be a safety hazard or cause equipment malfunction. Use extreme caution and follow instructions carefully.
	NOTE: This indicates information particularly important for optimal system operation. Follow instructions carefully.

Safety Instructions

	DANGER: Risk of electric shock. Risk of fire. Only qualified electricians should install, troubleshoot, or replace the AC Battery.
	DANGER: Risk of fire or explosion. Only qualified personnel, using personal protective equipment (PPE) should transport or handle the AC Battery.
	DANGER: Risk of explosion. Do not dispose of AC Battery(ies) in a fire or by burning. The AC Battery(ies) can explode.
	DANGER: Risk of fire. During use, when stored, or during transport, keep the AC Battery in an area that is well ventilated and protected from the elements, where ambient temperature is between -20° C and 50° C, and where relative humidity is between 5 and 95 percent.
	DANGER: Risk of fire. If the AC Battery generates smoke, remove AC power from the Enphase System so that charging/discharging stops.
	DANGER: Risk of electric shock. Risk of fire. Do not attempt to repair the AC Battery; it contains no user-serviceable parts. Tampering with or opening the AC Battery will void the warranty. Warranty void if the battery housing is removed. If the AC Battery fails, contact Enphase Customer Support for assistance at enphase.com/global/support/contact .
	DANGER: Risk of electric shock. Do not use Enphase equipment in a manner not specified by the manufacturer. Doing so may cause death or injury to persons, or damage to equipment.
	DANGER: Risk of electric shock. Do not install the AC Battery without first removing AC power from the photovoltaic system. Disconnect the power coming from the photovoltaics before servicing or installing.
	DANGER: Risk of electric shock. Always de-energise the AC branch circuit during an emergency and/or before servicing the AC Battery. Never disconnect the DC connectors under load.
	DANGER: Risk of electric shock. Risk of high short-circuit current. Observe the following precautions when working on batteries: <ul style="list-style-type: none"> • Remove watches, rings, or other metal objects. • Use tools with insulated handles. • Wear rubber gloves and boots. • Do not lay tools or metal parts on top of batteries.
	DANGER: Risk of electric shock. Risk of fire. Do not work alone. Someone should be in the range of your voice or close enough to come to your aid when you work with or near electrical equipment.
	DANGER: Risk of fire. Do not allow or place flammable, sparking, or explosive items near the AC Battery.
	WARNING: Risk of equipment damage. During use, storage, transport, or installation, always keep the AC Battery in an upright position.

Safety Instructions, continued

	WARNING: You must install the AC Battery only on a suitable wall using an Enphase wall-mount bracket.
	WARNING: Before installing or using the AC Battery, read all instructions and cautionary markings in this guide and on the equipment.
	WARNING: Do not install or use the AC Battery if it has been damaged in any way.
	WARNING: Do not exceed the maximum number (13) of AC Batteries in an AC branch circuit.
	WARNING: Do not sit on, place objects on, or insert objects into the AC Battery.
	WARNING: The AC Battery is not waterproof. Do not place beverages or liquid containers on top of the AC Battery. Do not expose the AC Battery to liquids or flooding.
	WARNING: Damage to the battery can occur from over-discharge. While in storage, the AC Battery will discharge. If the battery state of charge falls below 0%, the AC Battery can be damaged or destroyed. Because of this, the AC Battery must only be stored a limited amount of time. <ul style="list-style-type: none"> • The AC Battery must be installed and energised by the "Must Energize By" date on the shipping box label. • The AC Battery must have a charge state of at least 30% when placed in storage. • If the AC Battery has already been installed, it must be placed into Sleep Mode prior to uninstalling. A battery in Sleep Mode can be stored a maximum of two months from the date it was placed into Sleep Mode. • When placing the AC Battery in storage, ensure that the DC connector is unplugged.
	NOTE: Perform installation and wiring in accordance with all applicable local electrical codes and standards.
	NOTE: Protection against lightning and resulting voltage surge must be in accordance with local standards.
	NOTE: Using unapproved attachments or accessories could result in damage or injury.
	NOTE: Use Class 1 wiring methods for field wiring connections to terminals of a Class 2 circuit. Use only 2.5mm ² to 4mm ² wire in the junction box terminal block. Select the wire size based on the protection provided by the circuit breakers / fuses. Install over current protection as part of the system installation.
	NOTE: To ensure optimal reliability and to meet warranty requirements, the AC Battery must be installed and/or stored according to the instructions in this guide.
	NOTE: The AC Battery is compatible only with the Envoy-S, Metered communications gateway, which is required for operation of the AC Battery. Earlier versions of the Enphase Envoy communications gateway, and non-metered gateways are incompatible.
	NOTE: The Enphase AC Battery is intended to operate with an Internet connection. Failure to maintain an Internet connection may have an impact on the warranty. See Limited Warranty for full terms and services (enphase.com/warranty).
	NOTE: When replacing an Enphase AC Battery, you must replace it with an AC Battery of the same type, with the same AC current rating.
	NOTE: When stored, the AC Battery is not connected to the grid and no automatic charge of the battery is possible.
	NOTE: Never leave the battery on its back for more than five minutes. The battery cells are meant to be in the upright position.
	NOTE: Properly mount the AC Battery or place it on a flat, plain surface that can bear heavy weights. Ensure that the mounting location is structurally suited to bearing the weight of the AC Battery.
	NOTE: During use, storage, and transport, keep the AC Battery: <ul style="list-style-type: none"> • Properly ventilated • Away from water, other liquids, heat, sparks, and direct sunlight • Away from excessive dust, corrosive and explosive gases, and oil smoke • Away from direct exposure to gas exhaust, such as from motor vehicles • Free of vibrations • Away from falling or moving objects, including motor vehicles • At an elevation of fewer than 2,000m above sea-level • In a location compliant with fire safety regulations (has a smoke detector) • In a location compliant with local building codes and standards
	NOTE: Conditions for the AC Battery installation site apply also to storage conditions.