

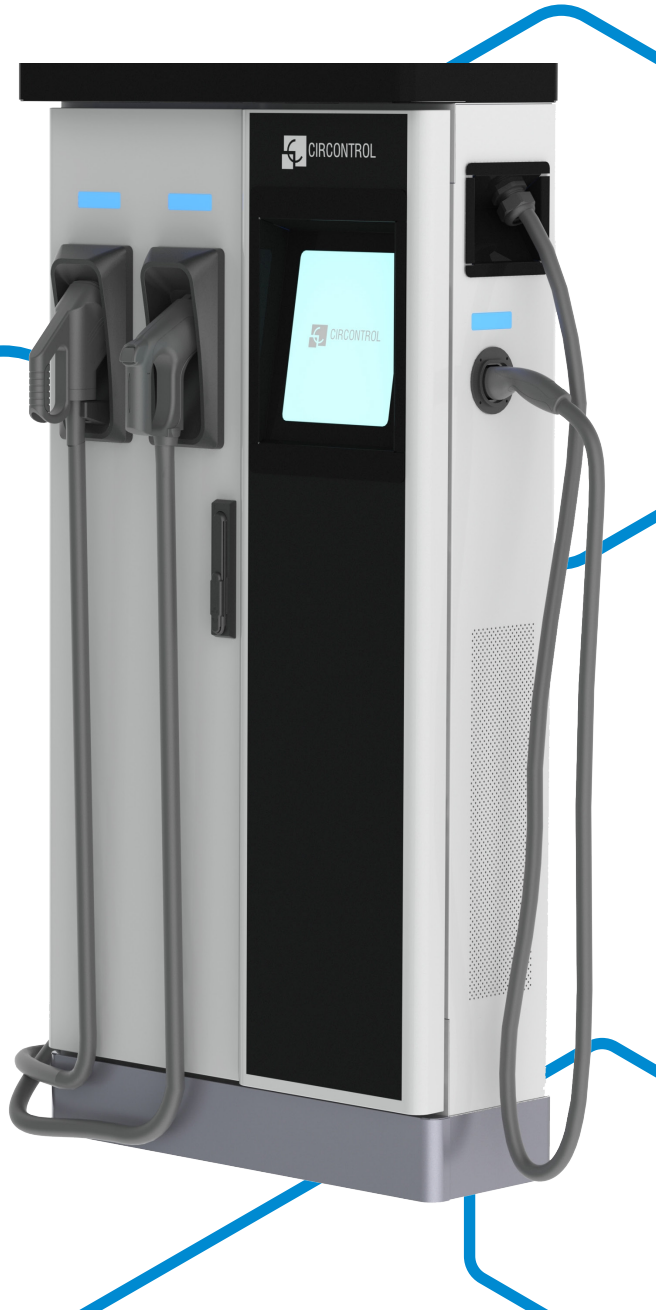

**CIRCONTROL**  
*Mobility & eMobility*

# Raption 50 Series

Installation Manual





# **Raption 50 Series Installation Manual**

## **COPYRIGHT INFORMATION**

This document is copyrighted, 2017 by Circontrol, S.A. All rights are reserved. Circontrol, S.A. reserves the right to make improvements to the products described in this manual at any time without notice.

No part of this manual can be reproduced, copied, translated or transmitted in any form or by any means without the prior written permission of the original manufacturer. Information provided in this manual is intended to be accurate and reliable. However, the original manufacturer assumes no responsibility for its use, or for any infringements upon the rights of third parties that may result from its use.

All other product names or trademarks are properties of their respective owners.



# Here's your guide to install Raption 50

1 — So, hello!	02	4 — Installation	12
2 — Before the installation	04	5 — Technical Data	30
3 — Dimensions and Overview	10	6 — Need Help?	34

# 1

This manual provides information for installing the Charge Point, which has been designed and tested to allow charging electric vehicles, as specified at IEC 61851 standards.

This document has different sections describing electrical components inside the Charge Point and a step-by-step installation procedure.

It is mandatory to follow the basic security information supplied in this manual to ensure safe and proper installation.

Failure to follow safety instructions may involve personal injury, equipment damage and danger of death. CIRCONTROL is not responsible for events arising from such breach.

## THE FOLLOWING SYMBOLS ARE USED FOR IMPORTANT SAFETY INFORMATION IN THIS DOCUMENT

### ELECTRIC RISK



- This symbol indicates a potentially hazardous situation which, if not avoided may result in a risk of fire, serious injury or death.

- The Charge Point must be disconnected from any power source before performing any maintenance, repair or electrical manipulation inside.

### ATTENTION!



- Follow the instructions preceded by this symbol, if not respect them or perform them correctly, may result in minor or moderate injury to the user, damage to equipment, damage to facilities or other property.

- Handling the equipment can cause injuries as result of the dimension and weight. Persons handling the unit must wear safety shoes and gloves.

# So, hello!

- Compliant with IEC 61851; Electric vehicle conductive charging system (IEC 61851-1, IEC 61851-22 and IEC 61851-23).
- Compliant with IEC 62196; Plugs, sockets-outlets, vehicle connectors and vehicles inlets, Conductive charging of electric vehicles (IEC 62196-1, IEC 62196-2 and IEC 62196-3).
- Compliant with CHAdeMO certification.
- Meets the CCS specification, DIN 70121
- Directives: 2014/53/UE, Radio and Telecommunication Terminal equipment; 2014/30/UE, Electromagnetic Compatibility (EMC); 2014/35/UE, Low Voltage directive.
- RFID complies with ISO 14443A/B

## 2

### A

## Important safety instruction



Read carefully all the instructions before starting in order to ensure properly installation of the charge point.

The Charge Point is designed for installation at indoor and outdoor areas. For each of the different conditions of installation, the unit must be installed safely and ensure adequate protection.

- Charge point must not be installed in areas where there is potential risk of explosions.
- Do not install the Charge Point where falling objects may damage the equipment.
- The surface where the Charge Point is placed must withstand the mechanical forces.
- Do not use this unit for anything other than electric vehicle charging modes are expected in IEC 61851.
- Do not modify this unit. If modified, CIRCONTROL will reject all responsibility and the warranty will be void.
- Comply strictly with electrical safety regulations according to your country.
- Do not make repairs or manipulations with the unit energized.
- Only trained and qualified personnel should have access to the electrical parts inside the Charge Point.
- Check the installation annually by qualified technician.
- Remove from service any item that has a fault that could be dangerous for users (broken plugs, caps that don't close...).
- Use only Circontrol supplied spare parts.
- Do not use this unit if the enclosure or the EV connector is broken, cracked, open, or shows any other indication of damage.



# Before the installation

## **B** Electrical wiring considerations



Take into consideration this section before start wiring connections of the charge point.

### **1 – INPUT POWER SUPPLY**

The input power supply line for the Charge Point, must be hardwired from a distribution board to the Charge Point under electrical safety regulations according to your country regulations.

### **2 – POWER SUPPLY LINE DIMENSIONING**

The dimensioning of the input power supply line of the Charge Point must be checked by a qualified electrician. Note that various factors such as cable length between distribution board and the Charge Point, maximum input current of the Charge Point and the installation way may have influence of the selected cable.

In such cases, increasing the cable cross-section can be necessary.

### **3 – MAXIMUM CURRENT OUTPUT**

Depending of the input power supply line, it will be possible to have more or less maximum output current by software limitation. Please refer to the Technical Data section to consult the default factory settings from maximum output current of the Charge Point.

If the input power supply is less than maximum output current required, an adjustment to a lower nominal current needs to be performed, please refer to the Instruction Manual.

## Supply and storage

### 1 – SUPPLY

All the units pass their correspondent quality test and are properly packaged for safe transportation ensuring thus their correct operation. The proper transport of the unit is responsibility of the freight forwarder.

Upon receipt of the Charge Point make a careful inspection to verify that there is no shipping damage.



**Note:** If any damage caused by the forwarder is not indicated in the delivery note during the receipt of the Charge Point, CIRCONTROL will not be held responsible for the cost of repair/replacement.

You must find inside of the box, the foundation kit, the decorative panels and two carton box, one of them with the connectors inside and the other with the rest of material, such as keys, identification cards, installation manual, etc.

## What's included:

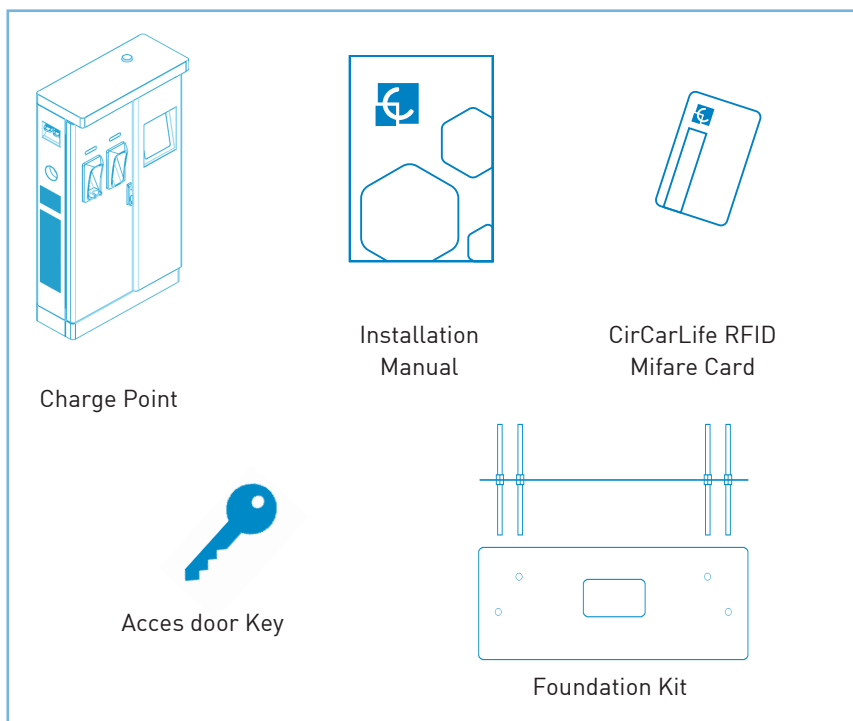

## 2 – STORAGE

Whenever possible, the Charge point must be unloaded in their place of installation and operation. In case of unloaded to a temporary location for storage, it is convenient to not remove the packaging and store them meeting the following minimum requirements:

**Safety:** Charge Point must be protected against negative elements such as heat radiation, direct solar radiation, mechanical damage, organic dissolvent impacts, etc.

**Temperature:** for temperatures below  $-20^{\circ}\text{C}$  and over  $60^{\circ}\text{C}$  special attention must be paid to the storage and handling.

**Environment:** Charge Point must be stored in a dry and dust-free location. The distance from a heat source must be 1 m away. Outdoor storage of the unit has to be avoided.

## **D** Unloading and handling

All processes of unloading and handling of the Charge Point must be executed and monitored by qualified personnel attending to the significant weight of the unit, complying with safety rules and using the appropriate points of support. Important notes:

- The delivery truck only unloads the pallet carrying the Charge Point
- The delivery truck does not have the lifting facilities to move the Charge Point to its final location
- The placement of the Charge Point to its final location is the responsibility of the contractor

Once the Charge Point is already unloading from the truck, move it to its final location with a fork lift.





# 3

## A Dimensions

- Units specified in millimeters:

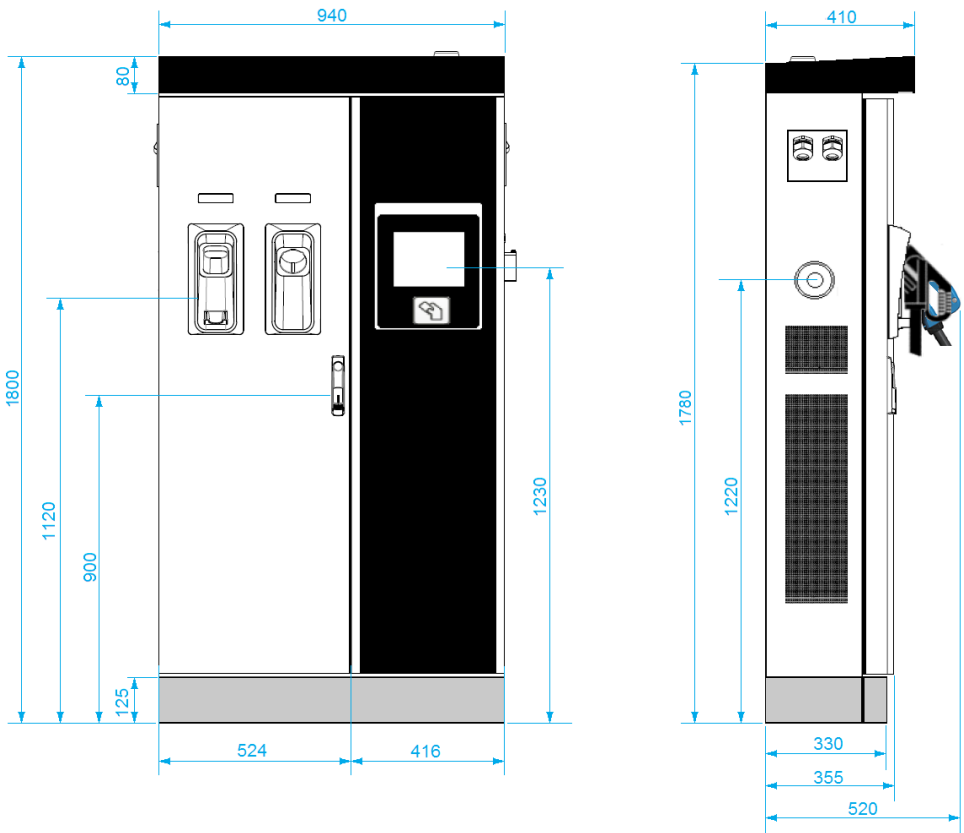

# Dimensions and Overview

## B Overview

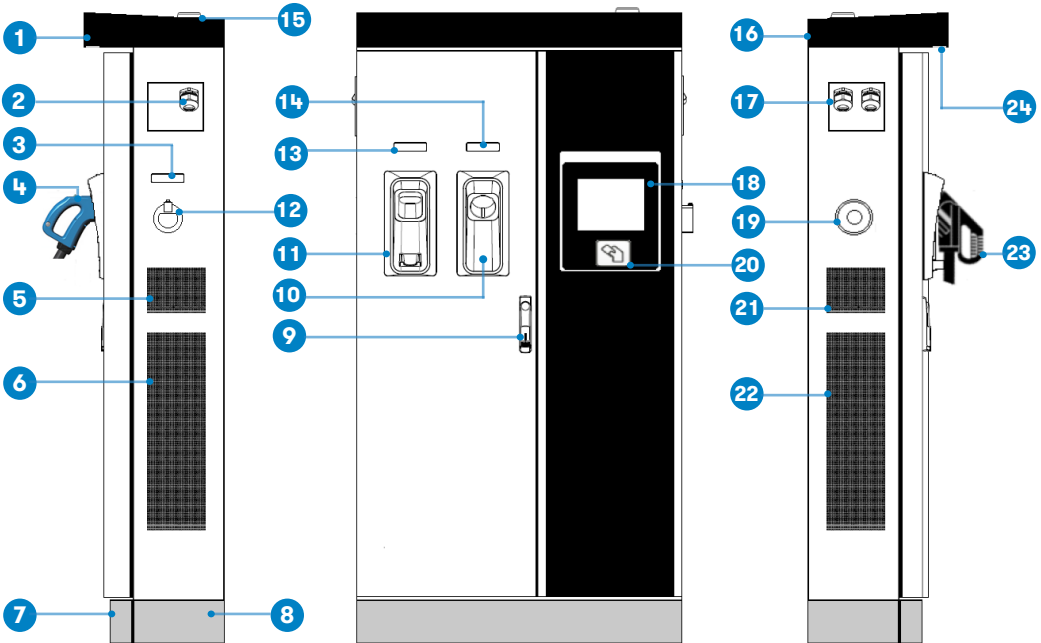

1- Cover	2- exit AC cable	3- AC light beacon	4- CHAdeMO connector	5- Unit air inlet
6- Power M. air outlet	7- D. front panel	8- D. rear panel	9- Handle	10- CHAdeMO holder
11- CCS holder	12- AC holder or socket 32A *	13- CCS light beacon	14- CHAdeMO light beacon	15- 3G Antenna
16- Unit air outlet	17- exit DC cable	18- Touch screen	19- Emergency button	20- RFID reader
21- Unit air inlet	22- Power M. air inlet	23- CCS connector	24- Courtesy light	

(\*) Depending of the model, the components can vary.

## 4

## A Minimum distances

When installing the Charge Point, respect the minimum distances space for maintenance and safety reasons.

Please comply accordingly to your country specifications.

The next picture shows how it should be installed.

- Do not install near areas where water or fluids can penetrate into the unit.
- Do not install the Charge Point on unstable terrain.

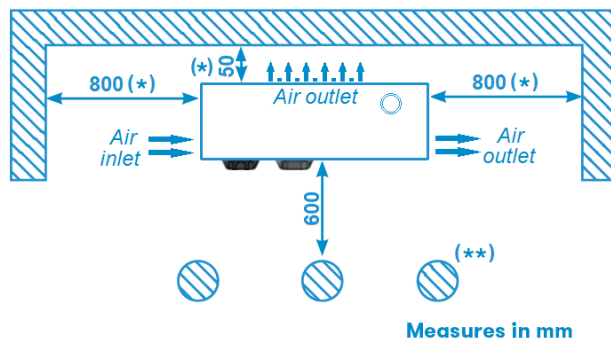

(\*) Respects the minimum lateral distance to allow proper circulation of air flow. This unit has forced ventilation.

(\*\*) If Bollard Impact Protector is installed, keep **600 mm** as a minimum distance in order to give enough space to open the frontal door of the Charge Point for maintenance tasks.



# Installation

## **B** Foundation

The purpose of this chapter is the technical definition and basic requirements for implement the base and fixing the Charge Point.

- The unit can be installed both inside and outside.
- A foundation kit with a mounting template is provided to ensure the distances between the foundation bolts.

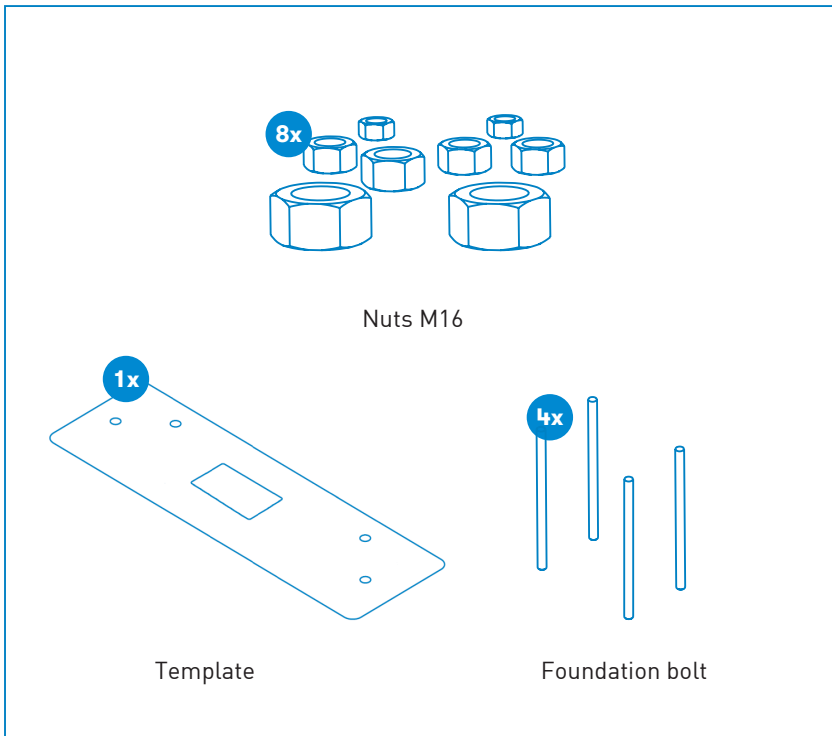

- Place the foundation bolts into the template using provided nuts with the help of a **24mm open-end wrench**. Take into consideration the following measures.

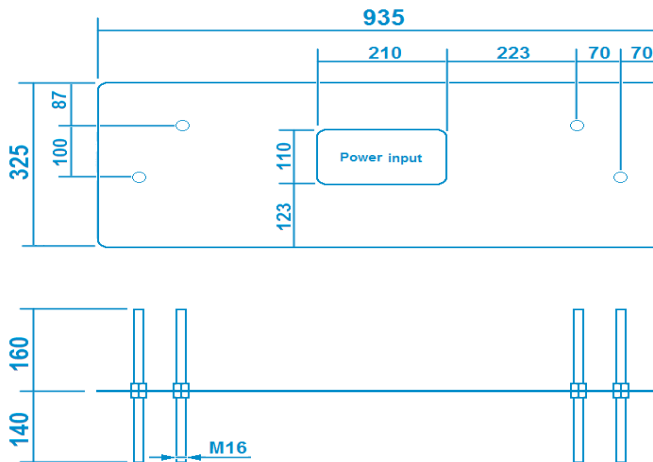
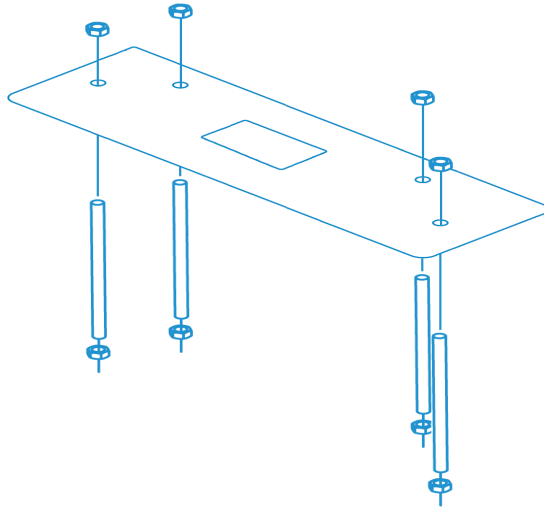

Measures in mm

- Once the kit is assembled, it must be placed in the ground. If the Charge Point has to be installed outside and there is no limitation of depth, is recommended to make a concrete base.
- The concrete base shall provide the passage of power cables, it must be done by corrugated tube placed inside the foundation through the mounting template, as it can be seen below:

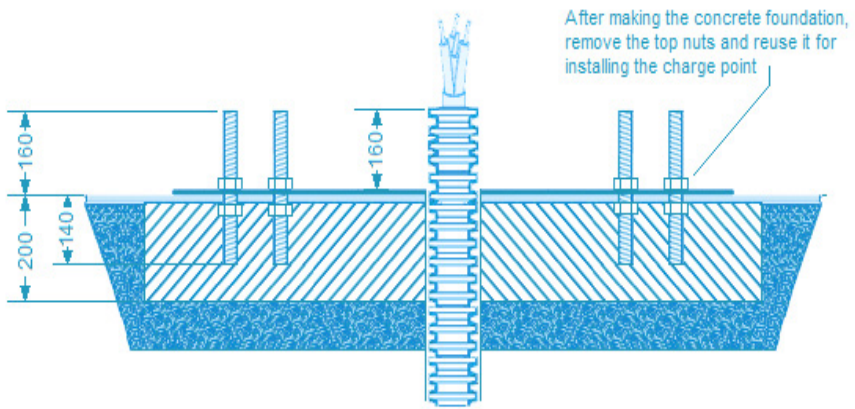

### Measures in mm

**Note:** In the event of any doubt about the terrain regarding the installation of the Charge Point, due to the weight and dimensions, it will be necessary to define a final solution to install the unit. It must be confirmed by a specific technical project made for an architectural firm prior to its installation.

# Opening

- Left door:

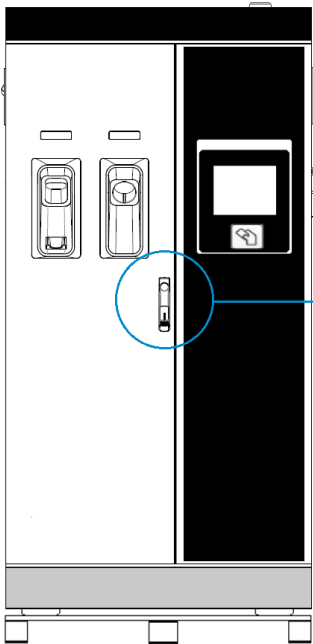

### Step 1



### Step 2

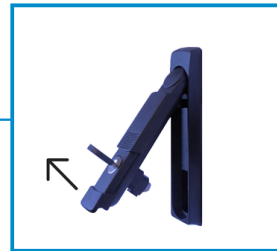

### Step 3

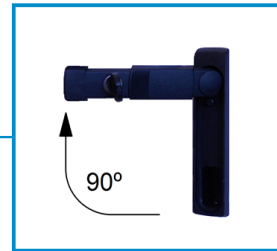

### Steps:

- 1- Insert the key supplied in the lock and turn it 90 ° counterclockwise.
- 2- Pull back the handle.
- 3- Turn the handle 90 ° clockwise direction.

- Right door:

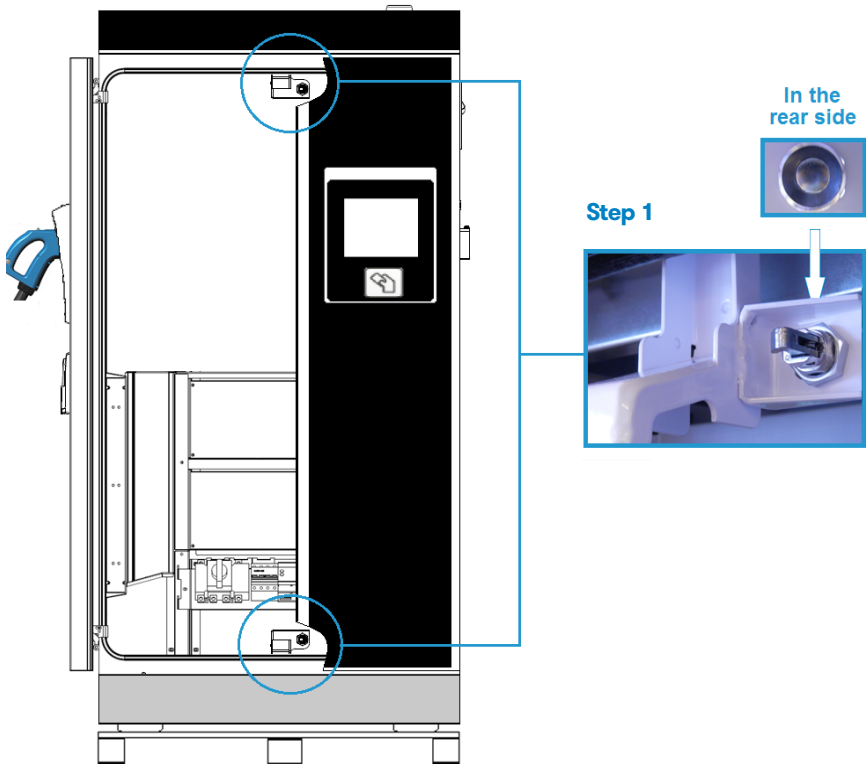

**Steps:**

1- Push on the round metallic button placed behind to the mechanic lock. On the top and bottom part of the Right door.

## **D** Placing

In order to place the Charge Point in its definitely place, please follow next steps:

### **1 – REMOVING THE CHARGE POINT FROM PALLET**

The Charge Point is mounted on a pallet so as to do a safe transport. It has to be removed before to install.

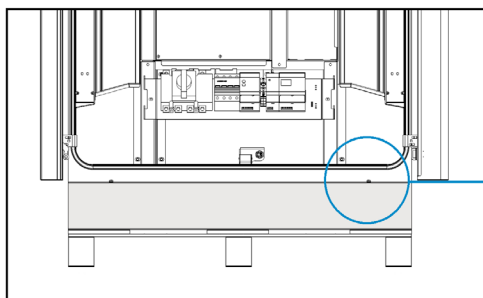

**Step 1**

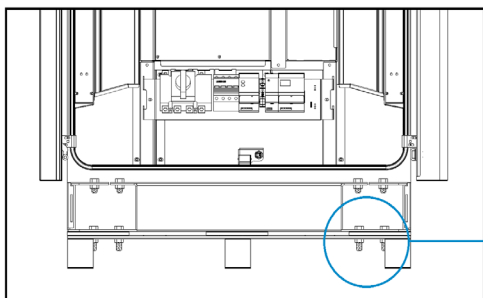

**Step 2**

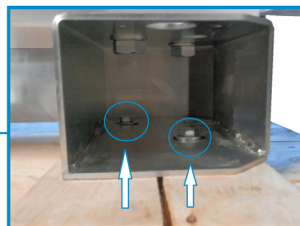

#### **Steps:**

- 1- Remove the screws from the Decorative front panel (on both sides) and pull outward it.
- 2- Once the Decorative front panel is removed, locate the screws that are keeping the pallet. Remove the screws with a 17 mm spanner tool.

## 2 — PLACING THE CHARGE POINT TO THE FINAL LOCATION

Once the Charge Point is free from the pallet, there are two options to move it to the final location.

### a) Move the Charge Point with eyebolts

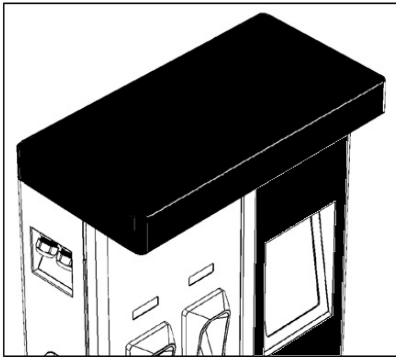

#### Step 1

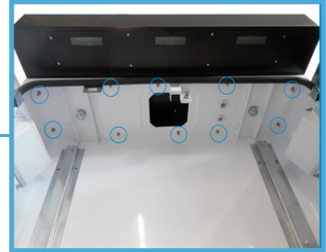

#### Step 2



#### Step 3

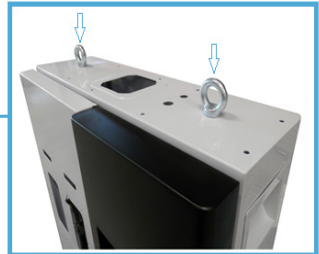

#### Steps:

- 1- Take off the 10 x M6 nuts that are keeping the cover, lift a little the cover and disconnect the 3G antenna connector, courtesy light connector and the exhaust fan connector.
- 2- Remove totally the cover from the top of the Charge Point.
- 3- Locate and make sure that the eyebolts provided are strongly tight.

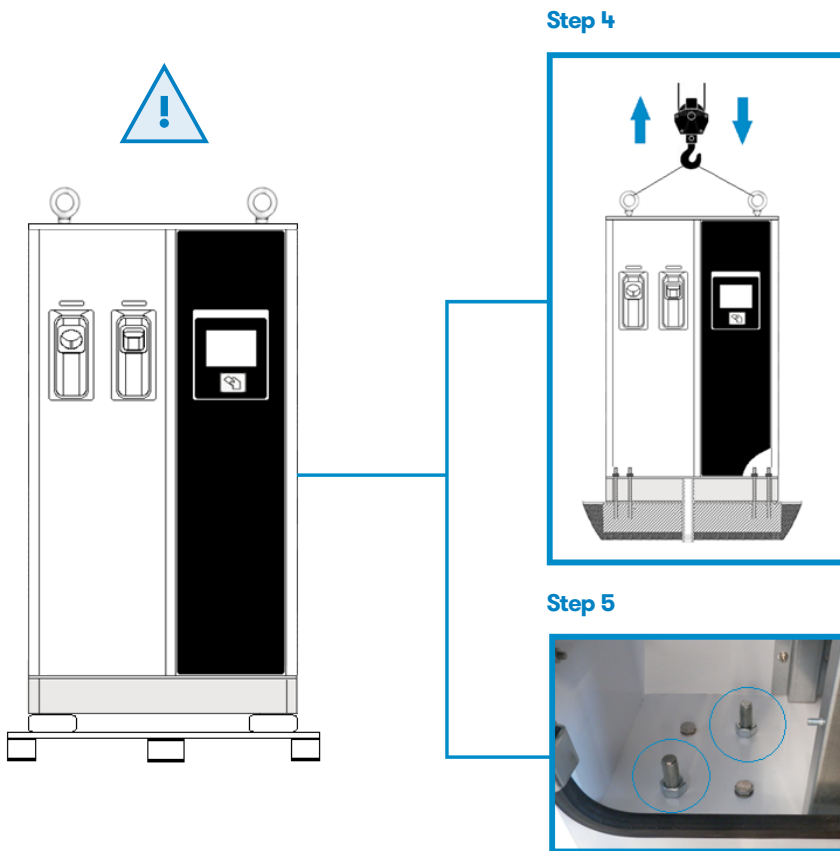

**Steps:**

4- Hold the sling to the eyebolts, raise the Charge Point up and placed on the final location.

5- Screw the 4 x M16 nuts with washers on the threaded rods already installed on the base (on both sides), place again the unit cover, connect the 3G antenna connector, courtesy light connector and the exhaust fan connector and assembly the decorative front panel.

**NOTE:** Do not remove the eyebolts from the Charge Point, leave it under the cover.



b) Move the Charge Point with manual forklift or forklift truck .

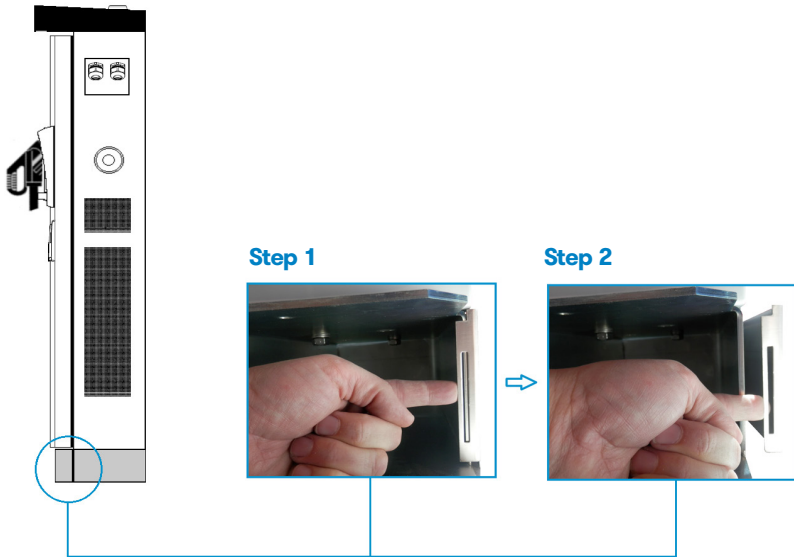

**Steps:**

- 1- Remove the decorative rear panel. Pull outward the metal flange (on both sides).
- 2- Move out the metal flange (on both sides) and remove the decorative rear panel.

Once the decorative panels have been removed, it will be available enough space to introduce the forklift, 560 mm

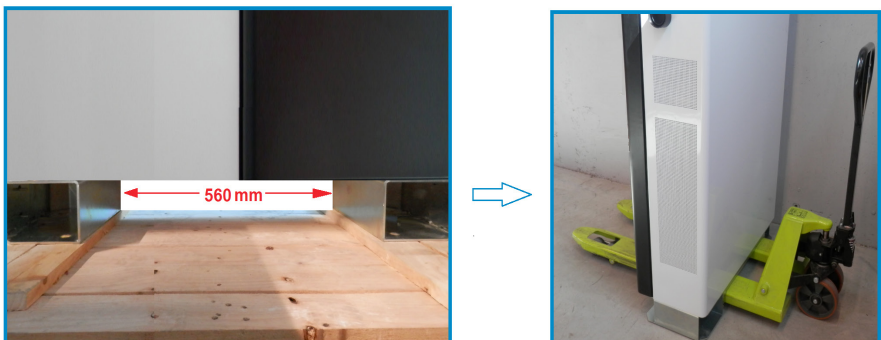

## Wiring

The power supply for the Charge Point must be done by a specific line of supply, with a general switch and a unique differential, installed according to the unit's consumption and the standards of local or state security. The installation company will be responsible for dimensioning the wires cross section and the electrical protections, taking into account the conditions of installation and distances.

Regardless of the electrical characteristics of the power line, be sure to supply to the Charge Point with the necessary electrical features indicated at the unit characteristics label, understood as, supply voltage, grid frequency and required apparent power. In the case that the power line characteristics are different from those required, must do the necessary adaptation of the same to meet this requirement.

The proper earthing system must be TT or TN-S

Before starting wiring connection for the Charge Point, have to be checked the following important elements:



- Make sure the main switch wiring (MCCB or fuses) of the AC power supply are cutting the electricity supply during installation.
- It is recommended to strictly follow the current regulations to determine the appropriate section of the power cables to feed the Charge Point and at any time as a minimum comply with indicated in the Technical Data here below.
- After unpacking the Charge Point, ensure that all electrical components are in good condition.
- After the installation, you must seal all holes inside the Charge Point to prevent access of dirt, foreign objects, animals, etc.

## Power input connection - Metal plate - :

In order to make a secure cable installation is recommended to use the metal plate provided.

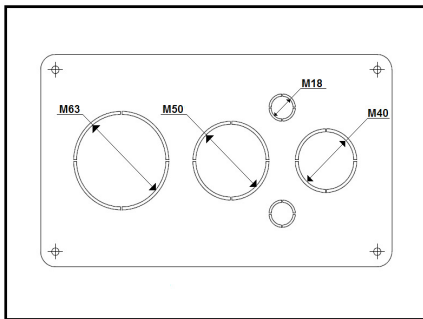

Step 1

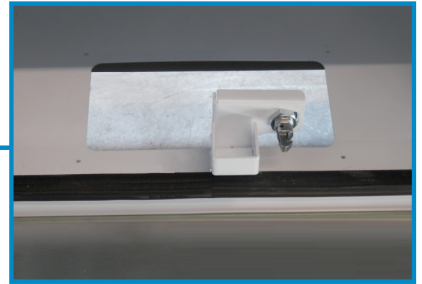

Step 2

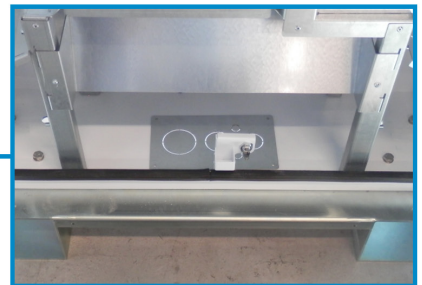

### Steps:

- 1- Locate the power input entrance in the bottom of the Charge Point.
- 2- Assembly the metal plate provided. It is recommended to install a cable glands (not supplied) in pre-holes position.

## Power input connection - Connecting cable -:

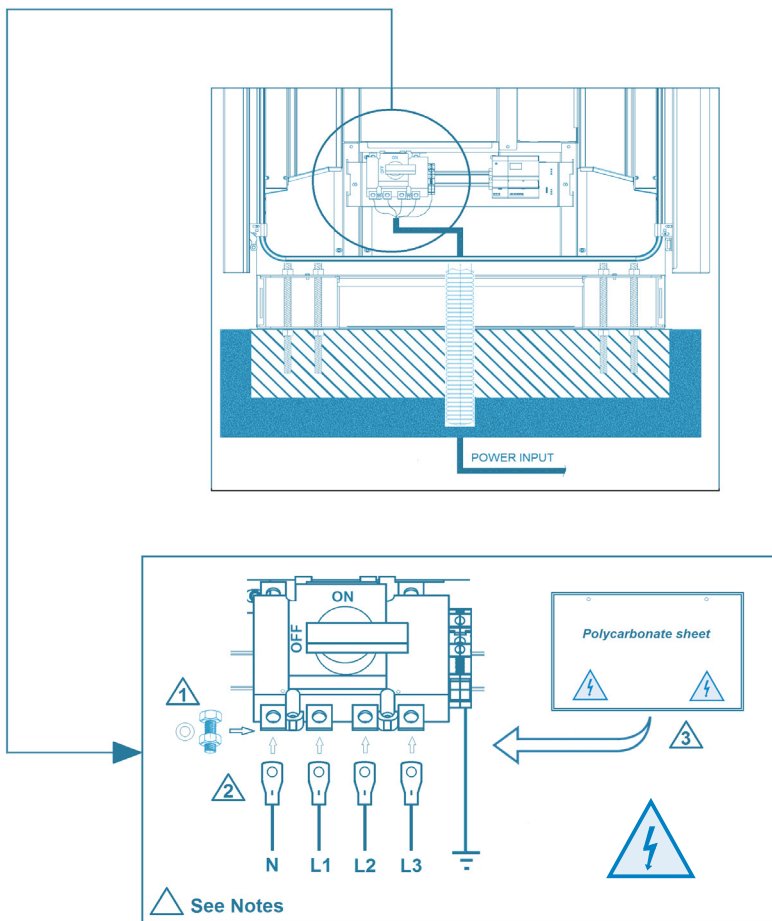

### Notes:

- 1- Use the M8 screw and washer provided in order to connect the electric terminals.
- 2- Use a M8 metallic electric terminal aligned with the required cable cross section according with the power of the Charge Point (Max. 95 mm<sup>2</sup>). See this requirement in the data sheet.
- 3- After connecting the power supply, place the shield protection over the circuit breaker.



MODEL SPECIFICATIONS				
	MODELS			
	CCS CHA T2C63	CCS CHA T2S32	CCS CHA	CCS T2S32
<b>Minimum cable cross section *</b>	70 mm <sup>2</sup>	50 mm <sup>2</sup>	25 mm <sup>2</sup>	50 mm <sup>2</sup>
<b>Maximum cable cross section</b>	95 mm <sup>2</sup>	95 mm <sup>2</sup>	95 mm <sup>2</sup>	95 mm <sup>2</sup>

MODEL SPECIFICATIONS			
	MODELS		
	CHA T2S32	CCS	CHA
<b>Minimum cable cross section *</b>	50 mm <sup>2</sup>	25 mm <sup>2</sup>	25 mm <sup>2</sup>
<b>Maximum cable cross section</b>	95 mm <sup>2</sup>	95 mm <sup>2</sup>	95 mm <sup>2</sup>

(\*) This is the minimum cable section for the maximum AC input current, the final section have to be calculated by the installer, taking into account the conditions of installation and distances.

## **F** Cellular connection

This section describes how to install the SIM card into the 3G modem.

### **1 – 3G MODEM LOCATION**

The modem is installed inside the Charge Point and the antenna is fixed outside, right on the roof of the unit.

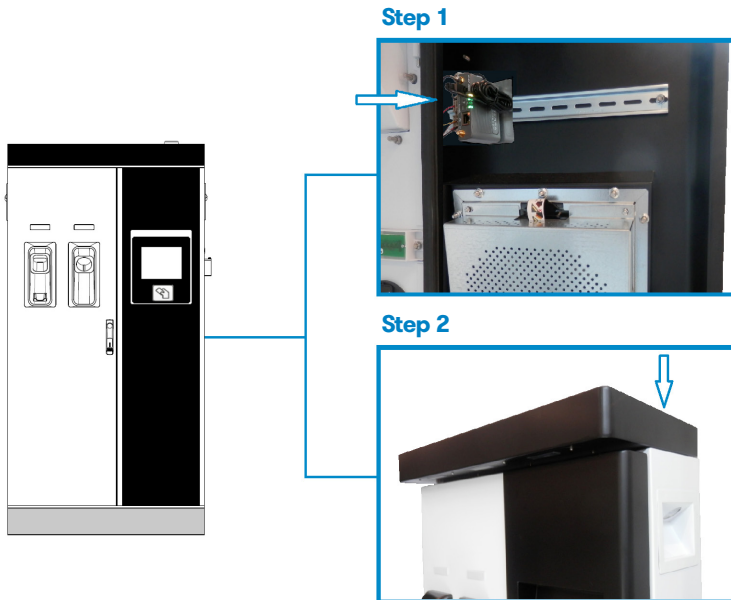

#### **Steps:**

- 1- Open the right door of the Charge Point and locate the 3G modem right on the rear side.
- 2- Check that the Charge Point is provided with the 3G antenna on the cover top.

## 2 – MODEM OVERVIEW

The 3G modem installed from factory in the unit is:

### Sierra Wireless AirLink LS300

This device allows the Charge Point to connect over 3G networks to remotely view or manage the Charge Point status.

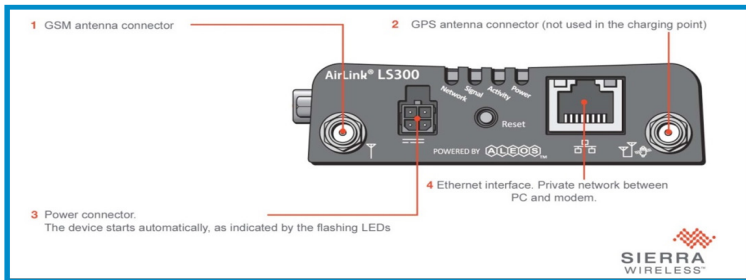

## 3 – MODEM INSTALLATION

Before installing the SIM card into the modem, make sure you have unplugged the power cord from the modem.

The following schematic explains in detail the proper installation of the SIM card:

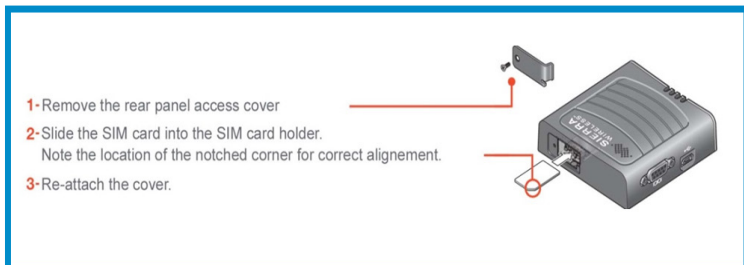

**NOTE:** SIM card not provided with the Charge Point.

#### 4 — MODEM CONFIGURATION

Plug again the power supply for the modem.

**NOTE:** After plugging back the modem, it can take until 5 minutes to respond.

3G modem configuration is performed using the Ethernet interface. Connect your computer using an Ethernet cable as shown in the following image:

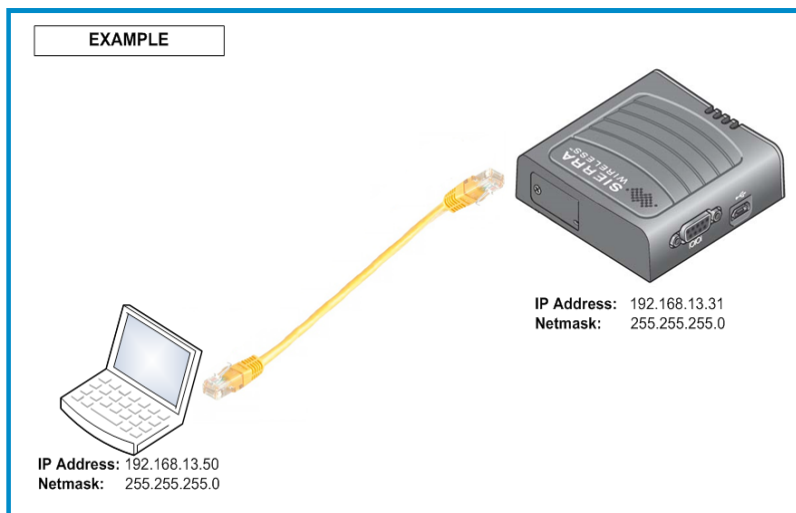

#### Steps:

- 1- Open a web browser in the computer and enter **http://192.168.13.31:9191**. Wait until ACE manager login screen appears.
- 2- Default username is **user** and default password is **12345**. Do not change the default credentials; the Charge Point requires consulting information from the 3G modem.
- 3- The ACE manager homepage appears. You can now configure each device with ACE manager.

For more information about how to configure the 3G modem in detail, please visit following website: **http://www.sierrawireless.com**



## Verification

Once completed the entire installation procedure, check the following points:

- Check that all the MCB, RCD and the Main Circuit Breaker are powered on. (\*)
- Check that all safety labels are correctly placed.
- Close the Charge Point's doors. The Charge Point has a security switch (anti-tamper protection) installed that will avoid any charging session if the doors are opened.
- Check that all beacons are illuminated in green.
- Verify that each EV connector is in good condition.
- Make sure the ventilation air flow is correct and there is not any obstruction at the ventilation grill.
- Check for abnormal noise while charging a vehicle.

(\*) In the case of the Charge Point is equipped with a Type 'B' RCD for AC side, after power up the Main Circuit Breaker (F3.1) the AC MCB (Q3.1) will trigger at first moment, it is due of the response time of the RCD, there is not a fault. Make a reset on the 'Trigger coil' (Q3.3) next to the AC MCB (Q3.1), Step 1, and lift up it, Step 2.

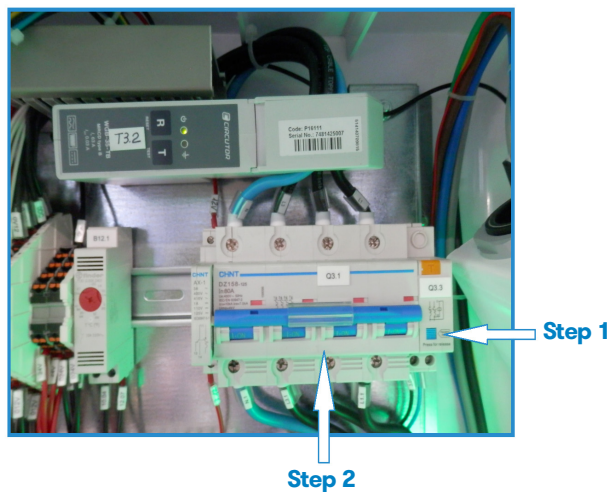

## 5

GENERAL DATA	
<b>Display</b>	LCD Multi-language touch screen
<b>Light beacon</b>	RGB Colour indicator
<b>RFID reader</b>	ISO / IEC 14443A/B MIFARE Classic/Desfire EV1 ISO 18092 / ECMA-340 NFC 13.56MHz
<b>Compliance</b>	IEC-61851; IEC-62196; CE; CHAdeMO Certified; CCS (DIN 70121)

MECHANICAL DATA			
<b>Enclosure rating</b>	IP54 / IK10		
<b>Enclosure material</b>	Stainless steel		
<b>Enclosure access</b>	Frontal key locked door		
<b>Connector type</b>	AC	DC	
	Type 2 tethered cable / socket	JEVS G105	CCS 2
<b>Cable length</b>	3 meters / ---	3 meters	3 meters
<b>Net weight</b>	235 Kg		
<b>Dimensions (W x H x D)</b>	940 x 1800 x 355 mm		

ENVIRONMENTAL CONDITIONS	
<b>Operating temperature</b>	-30°C to +45°C
<b>Storage temperature</b>	-20°C to +60°C
<b>Operating humidity</b>	5% to 95% Non-condensing
<b>Sound level in operation</b>	< 55 dB

# Technical Data

CONNECTIVITY	
<b>Ethernet</b>	10/100BaseTX (TCP-IP)
<b>Cellular</b>	Modem 3G / GPRS / GSM *
<b>Interface protocol</b>	OCPP

ELECTRICAL DATA	
<b>Power supply</b>	3P+N+PE
<b>Voltage range</b>	400 VAC +/- 10%
<b>Power factor</b>	> 0.98
<b>Efficiency</b>	95 % at nominal output power
<b>Standby consumption</b>	38 W
<b>THDi</b>	< 5%
<b>Frequency</b>	50/60 Hz
<b>Electrical protections</b>	Overcurrent protection, RCD and Overvoltage protection *
<b>AC electrical meter</b>	Complies with the EN 50470 (MID European standards)

[\*] Depending on the model, these components are optional.

MODEL SPECIFICATIONS				
	MODELS			
	CCS CHA T2C63	CCS CHA T2S32	CCS CHA	CCS T2S32
<b>Maximum AC input current</b>	138 A	108 A	76 A	108 A
<b>Required power supply capacity</b>	96 KVA	75 KVA	53 KVA	75 KVA
<b>Maximum output power</b>	DC: 50 kW AC: 44 kW	DC: 50 kW AC: 22 kW	DC: 50 kW	DC: 50 kW AC: 22 kW
<b>Output voltage range</b>	DC: 50-500 VDC AC: 400 VAC	DC: 50-500 VDC AC: 400 VAC	DC:50-500 VDC	DC: 50-500 VDC AC: 400 VAC
<b>Maximum output current</b>	DC: 0-125 A AC: 63 A	DC: 0-125 A AC: 32 A	DC: 0-125 A	DC: 0-125 A AC: 32 A
<b>Number of connectors</b>	3	3	2	2
<b>Connector type</b>	CCS2; JEVS G105; Type 2 tethered cable	CCS2; JEVS G105; Type 2 socket	CCS2; JEVS G105;	CCS2; Type 2 socket



MODEL SPECIFICATIONS			
	MODELS		
	CHA T2S32	CCS	CHA
<b>Maximum AC input current</b>	108 A	76 A	76 A
<b>Required power supply capacity</b>	75 KVA	53 KVA	53 KVA
<b>Maximum output power</b>	DC: 50 kW AC: 22 kW	DC: 50 kW	DC: 50 kW
<b>Output voltage range</b>	DC: 50-500 VDC AC: 400 VAC	DC: 50-500 VDC	DC:50-500 VDC
<b>Maximum output current</b>	DC: 0-125 A AC: 32 A	DC: 0-125 A	DC: 0-125 A
<b>Number of connectors</b>	2	1	1
<b>Connector type</b>	JEVS G105; Type 2 socket	CCS2	JEVS G105



# Need help?

In case of any query or need further information, please contact our **Post-Sales Department**



[ps-support@circontrol.com](mailto:ps-support@circontrol.com)



[circontrol.com](http://circontrol.com)



(+34) 937 362 940



(+34) 937 362 941



**CIRCONTROL**

*Mobility & eMobility*

**CIRCONTROL Raption 50 Series  
INSTALLATION MANUAL**

A comprehensive guide on  
how to install and verify your  
Raption 50 Charge Point.

V1.1, July edition 2017